

**Turbine Flow Meter
Transmitter Operation Manual
(FC001-V2.0 Version)**

CATALOG

1. Product Function Specification	PAGE 3
1.1 Base function	
1.2 Working conditions	
1.3 Transmitter Type	
2. Transmitter Operation And Parameter Setting	.PAGE 6
2.1 Keyboard Definition and Display	
2.2 Transmitter Menu Structure	
2.3 Transmitter Parameter Description	
2.4 How to Setup The Parameter	
3. Wiring Diagram And Output Define	PAGE 16
3.1 4-20mA Current Output Wiring Diagram	
3.2 Pulse Output Wiring Diagram	
3.3 Wiring Between Transmitter And Sensor	
3.4 Frequency Output Mode	
3.5 Pulse Equivalent Output Mode	
3.6 Analog Output Mode (4-20mA)	
4. Key Points of Attention	PAGE 19
4.1 Install	
4.2 Set Up Key Parameters of Flowmeter	
5.Packing and Storage	PAGE 21
6.Appendix	.PAGE 21
RS485 Communication Address Table	

1. Product Function Specification

1.1 Base Function

Turbine Sensor Struction Type

Flange connection type Liquid Turbine flow sensor

Thread connection type Liquid Turbine flow sensor

clamping band connection type Liquid Turbine flow sensor

Flange connection type Gas Turnine Flow Sensor

Suitable to Size of the Sensor (mm)

Flange connection type liquid turbine flow meter, size is DN10 to DN200

Thread connection type liquid turbine flow meter, size is DN4 to DN65

Clamping connection type liquid turbine flow meter ,size is DN15 to DN50

Power Supply

24VDC & 3.6V lithium battery,(double power supply) ;220VAC± 10%, 50/60HZ

Output Signal

Current output: 4 to 20mA,load resistance: 0~750Ω,Base deviation: 0.1%±10μA。

Frequency output: Frequency range is 10~5000Hz; Photoelectric isolation, isolation voltage: > 1000VDC;

Pulse equivalent output: user defined pulse width,automatic conversion to square wave at high frequency

Photoelectric isolation, isolation voltage: > 1000VDC;

If only 3.6v battery power supply, then without any output signal. And without communcation

Alarm Output

Alarm output contact : **H-ALM** and **L-ALM** ; Photoelectric isolation, isolation voltage : > 1000VDC ; Output driver: Maximum withstand voltage 36VDC, maximum load current 30mA.

Communcation

Communication : RS485 (option)、HART (option)

Language And LCD Dispaly

English ,With LCD,display flow rate , total flow , velocity and frequency etc

For two-wire output mode , then LCD display without backlight

For three-wire output mode , LCD display backlight

Multi segment Nonlinear Correction Function

Accuracy of Flow Meter: ±0.5% of reading ; ±0.25% of reading (option)

Compensation Function(for gas turbine flow meter):

With temperature and pressure compensation , display the temperature and pressure of fluid and density .

The flow meter can automatically carry out the conversion of working condition and standards condition

If for liquid turbine flow meter , without this function

1.2 Working conditions

Ambient temperature: -20~+65℃; Relative humidity: 5%~90%; Fluid temperature : ≤120 °C

1.3 Transmitter Type

FT8110 serial turbine flow transmitter have two type main board.

Transmitter Type	Main Features
FT8110E	LCD without backlight display flowrate and total flow, Only 4 to 20Ma & pulse output. with RS485.no alarm signal output. Two wire system. Suitable to liquid turbine flow sensor
FT8110H	LCD with backlight,display flowrate and total flow, 4 to 20Ma & pulse output. with RS485. with alarm signal output,, with temperature and pressure

compensation , two wire system and three wire system.
 Suitable to liquid turbine flow sensor and gas turbine flow sensor

2. Transmitter Operation And Parameter Setting

2.1 Keyboard Definition and Display

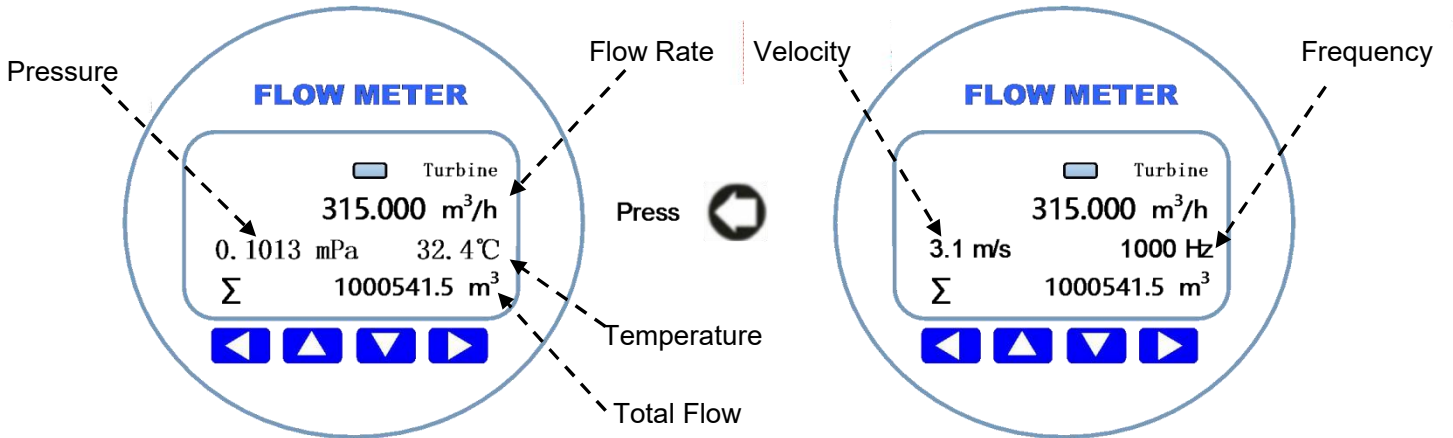

Left shift, parameter setting confirmation key and exit sub directory key



fast button to go to <factory setup>, digital up key.



move up and down keys



move right, enter the parameter setting and exit key

2.2 Transmitter Menu Structure

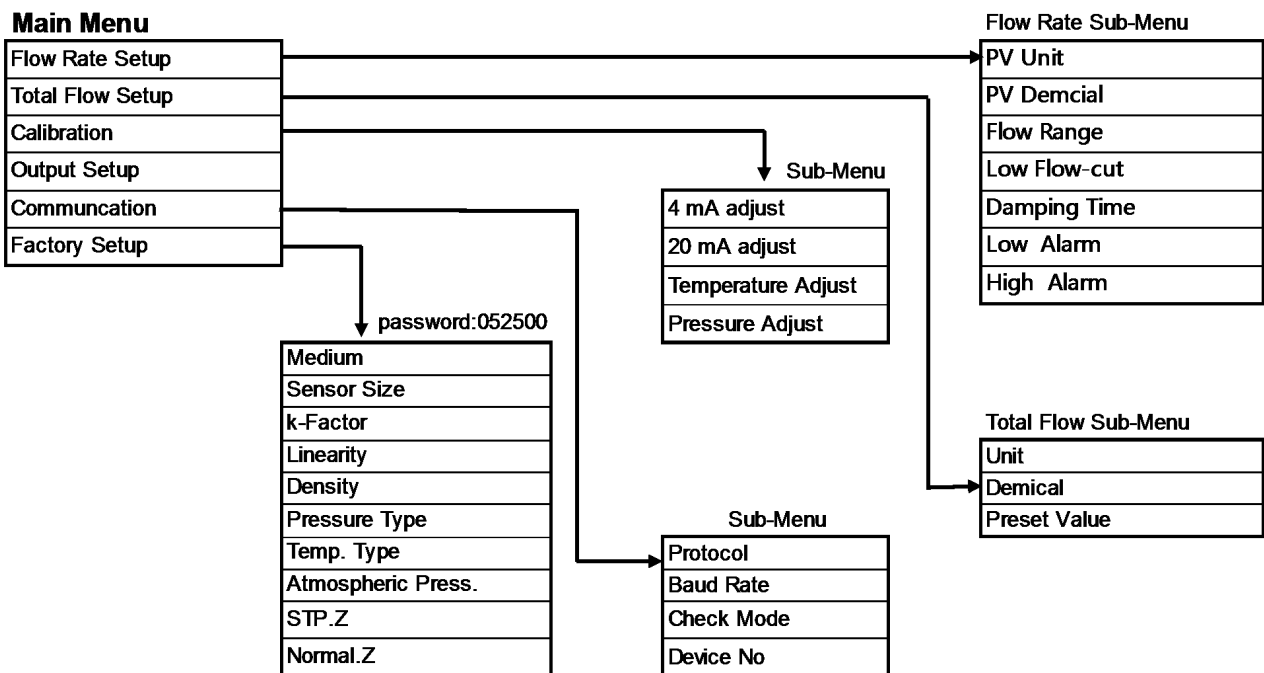

2.3 Transmitter Parameter Description and setup

● Flow Rate Parameter Setting







PV Unit	Option: L/s L/m L/h m ³ /s m ³ /m m ³ /h Nm ³ /h USG/s USG/m USG/h Kg/s Kg/m Kg/h t/s t/m t/h Default = m ³ /h ; define the unit of the flow rate L (liter), h(hour), t(ton), s(second) , m(minute)
PV Decimal	Option: 0 1 2 3 , default = 1 Define the decimal point position of the flow rate.
Flow Range	Float point: 99999999.00-0.00 m ³ /h , default = 100.0 m ³ /h When the instantaneous flow rate reaches this set value, the output current is 20mA, Change this parameter will affect: current output, high and low flow alarm, etc. NOTE: when you modify the flow range , please pay attention to the flow range unit . you also can modify the flow range unit at here.
Low Flow Cut	Float point: 9.90 ~ 0.00 % , default = 0.0 % = The set value is a percentage.of flow range
Damping Time	Float point: 30.0 ~0.1 , default = 0.1
Low Alarm	Float point: 99.00 ~ 0.00 % , default = 0.0 % This value is a percentage of flow range. for example, if this value is setup to ten(10), then Equivalent to ten percent(10%) of flow range. If the Absolute value of instantaneous flow < (flow range × 10%),then the reansmitter willl otput the low alarm signal ,the contact of low alarm will close .
High Alarm	Float point: 99.00 ~ 1.00 % , default = 90.0 % This value is a percentage of flow range. for example, if this value is setup to ten(10), then Equivalent to ten percent(10%) of flow range. If the Absolute value of instantaneous flow > (flow range × 10%),then the reansmitter willl otput the high alarm signal ,the contact of high alarm will close .

● Total Flow Setup: Define the relevant parameters of the total flow.

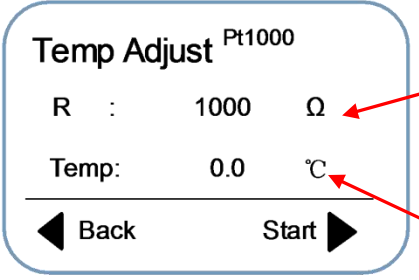
Unit	Option: L(liter) m ³ Nm ³ USG Kg t(ton) , Default value : m ³ define the total flow unit
Decimal	Option : 0 1 2 3 , Default value : 1 define the decimal point bit of the total flow value

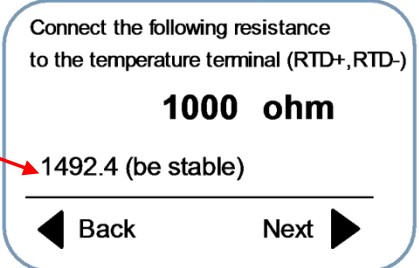
Preset Value	Option: 99999999.00-0.00 m3/h , Default = 0.0 m3/h Clear the total flow or Preser the value of the total flow
--------------	--

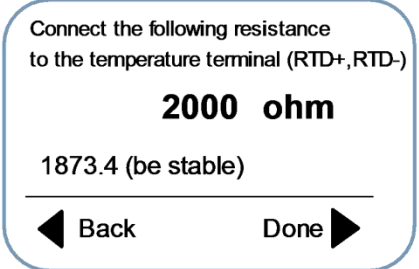
● **Calibration:** Adjust analog current output and temperature and pressure value.

4mA adjust	<p>Float point: 5.0~3.0 , default = 0.0</p> <p>After you go to this item, please use the Precision current meter to measure the current output value . if this result is not 4.0mA, then input the actual value which measure to this position .then The instrument will automatically complete the calibration operation .</p>
20mA adjust	<p>Float point: 21.0 ~19.0 , default = 0.0</p> <p>After you go to this item, please use the Precision current meter to measure the current output value . if this result is not 20.0mA, then input the actual value which measure to this position .then The instrument will automatically complete the calibration operation .</p>
<p>Temperature Adjust (only gas turbine flow meter)</p>	<div style="text-align: center;">  <p>Actual Resistance Value</p> <p>Actual Temperature Value</p> </div> <p style="text-align: center;">press </p> <div style="text-align: center;">  <p>Volatge value must be stable</p> </div> <p style="text-align: center;">press </p> <div style="text-align: center;">  </div> <p style="text-align: center;">Press the  , finishe the tempweature adjust.and back.</p>

Pressure Adjust
(only gas turbine
flow meter)

Auto Adjust
Input k&b
Zero cut off
◀ Back Start ▶

press  ↓

Multi point Calibration
put pressure to the sensor
input the actual pressure value
Gauge: 1.211 mPa
◀ Back Start ▶

Actual Pressure
(gauge pressure)

press  ↓

Pressure Zero
volatge: 10.0 mv
pressure : 0.0 mPa
◀ Next ▼ - + ▲ Shift ▶

According to the actual pressure
whcih provide to the pressure
sensor , you set up this value . for
"pressure zero" this setup is must
zero. this is setup the pressure
sensor zero.

press  ↓

Pressure Zero
volatge: 277.1 mv
pressure : 0.1013 mPa
◀ Back Save ▶

Finish the pressure zero calibration .

press  ↓

Pressure Adjust
(only gas turbine
flow meter)

Pressure Full
volatge: 277.1 mv
pressure : 0.1013 mPa
◀ Next ▼ - + ▲ Shift ▶

Provide the full range pressure to the sensor , and setup the actual pressure value .this step is finish the full range pressure calibration.

press  ↓

Pressure Full
volatge: 277.1 mv
pressure : 0.1013 mPa
◀ Back Save ▶

press  then back to the menu and finish the pressure calibration

press  ↓

P-Trim-1
volatge: 423.2 mv
pressure : 0.2 mPa
◀ Next ▼ - + ▲ Shift ▶

this is option .if the pressure sensor is nolinear , then you can use the following steps to adjust the linear of pressure sensor . you provide the any pressure to the sensor and setup . but this point is must greater than the pressure zero .

press  ↓

P-Trim-1
volatge: 669.5 mv
pressure : 0.3 mPa
◀ Back Save ▶

you also can press  to exit the next step

press  ↓

Pressure Adjust
(only gas turbine
flow meter)

P-Trim-2
volatge: 670.3 mv
pressure : 0.3 mPa
◀ Next ▼ - + ▲ Shift ▶

This step is option.
this value is must greater than P-Trim-1

press  ↓

P-Trim-2
volatge: 670.3 mv
pressure : 0.3 mPa
◀ Back Save ▶

you also can press  to exit the next step

press  ↓

P-Trim-3
volatge: 670.3 mv
pressure : 0.4 mPa
◀ Next ▼ - + ▲ Shift ▶

This step is option.
this value is must greater than P-Trim-2

press  ↓

P-Trim-3
volatge: 670.3 mv
pressure : 0.4 mPa
◀ Back Save ▶

you also can press  to exit the next step

press  ↓

Pressure Adjust
(only gas turbine
flow meter)

P-Trim-4

volatge: 670.3 mv

pressure : 0.5 mPa

◀ Next ▼ - + ▲ Shift ▶

press  ↓

P-Trim-4

volatge: 670.3 mv

pressure : 0.5 mPa

◀ Back Save ▶

press  to save and exit

This step is option.
this value is must greater than P-Trim-3

● **Output Setup:** setup the parameter of pulse output or frequency output

Max Frequency	<p>Floating point: 5000.0 - 100.0 Hz , default = 2000.0</p> <p>Output Frequency (Hz) = flow rate (m3/h) ÷ Flow range (m3/h) × Upper frequency limi (Hz)</p> <p>For example , the flowrate is 100m3/h, and the flow range is 200m3/h , and the “ Max Frequency ” is set to 2000HZ, then the output frequency is 1000HZ</p>
Pulse equivalent	<p>Floating point: 9999.0 – 0.0 , default = 0.0</p> <p>The “pulse equivalent” unit is “liter per one pulse: L/P” , you also can change this unit to : USG/P ,Kg/P , t/P , Nm³/P , m³/P</p>
Pulse width (ms)	<p>Floating point: 1000.0 ~ 0.0 ms , default = 0.0</p> <p>When this value is "0", the duty cycle of the output pulse is 1:1</p>
Signal	<p>Indicates that the current output mode is a direct signal output, but this signal is filtered and Linearity modified.</p>

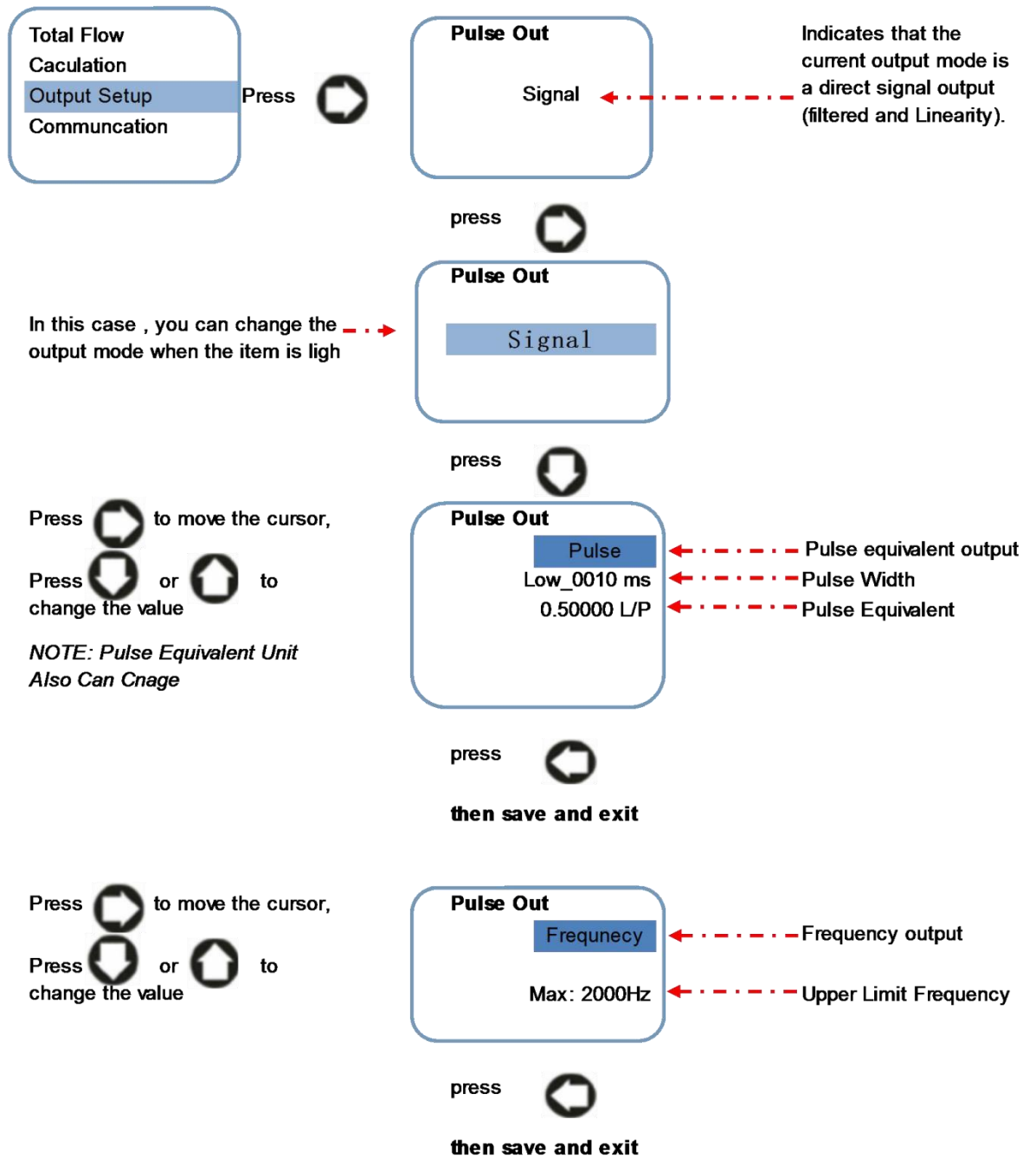

● **Communcation Setup:** setup RS485 communcation parameter

Protocol	option: Modbus-RTU Modbus-ASCII default: Modbus-RTU
Baud Rate	option: 1200 2400 4800 9600 19200 38400 default = 19200 Note: Please set the baud rate \geq 9600
Data Bit	option: 7 8 , default = 8 Note: if use RTU protocol, prohibit to choose “ 7 ”

Check Mode	option: None , Odd , Even default = Even
Device No	data: 247 ~ 1 , default = 1

- **Factory Parameter Setup:** Password **052500** . Setup the key parameters ,

Medium	<p>Option: gas oper-flow , gas normal-flow, Liquid flow Default: Liquid flow NOTE: Gas oper-flow: gas flow in working state Gas normal-flow: gas flow in standard state Liquid flow : the fluid is liquid, like water etc. Choose different item , then decide the different Algorithm in software</p>
Sensor Size	<p>Option: 4, 6, 10, 15, 20, 25, 32, 40, 50, 65, 80, 100, 125, 150, 200, 250, 300 mm default value = 50 mm for flange connection type liquid turbine flow meter, size is DN10 to DN200 for thread connection type liquid turbine flow meter, size is DN4 to DN65 For clamping connection type liquid turbine flow meter ,size is DN15 to DN50 For gas turbine flow meter,size is DN20 to DN300</p>
K-factor	<p>Floating point: 9.9000~0.0100 , default = 0.1 This parameter is determined when the real flow calibration is carried out. This parameter is only related to the sensor, which indicates the characteristic value of the sensor. Q (flow rate,m³/h) = 3600 × F(frequency,HZ) ÷ k (k-factor) After you finished the test , then need setup the final K-fator at here. K (k-factor) : Numbers of pulse per m³</p>

Linearity	<div style="display: flex; justify-content: space-around; align-items: flex-start;"> <div style="border: 1px solid black; border-radius: 15px; padding: 5px; width: 150px;"> Linearity 1 Linearity 2 Linearity 3 Linearity 4 Linearity 5 </div> <div style="text-align: center;"> Press </div> <div style="border: 1px solid black; border-radius: 15px; padding: 5px; width: 180px;"> Linear-1 0.0 HZ 0.0000 N/m³ </div> </div> <p style="margin-top: 20px;">in this menu , setup the frequency of test. F1, for example , the test point frequency is 60.3HZ</p> <div style="display: flex; justify-content: space-around; align-items: flex-start; margin-top: 20px;"> <div style="text-align: center;"> press </div> <div style="border: 1px solid black; border-radius: 15px; padding: 5px; width: 180px;"> Linear-1 000000.0 HZ 0.0000 N/m³ </div> </div> <p style="margin-top: 20px;">in this menu , setup the K-Factor corresponding to frequency (setup just now) , for example 1000</p> <div style="display: flex; justify-content: space-around; align-items: flex-start; margin-top: 20px;"> <div style="text-align: center;"> press </div> <div style="border: 1px solid black; border-radius: 15px; padding: 5px; width: 180px;"> Linear-1 60.3 HZ 0.0000 N/m³ </div> </div> <div style="display: flex; justify-content: space-around; align-items: flex-start; margin-top: 20px;"> <div style="text-align: center;"> press </div> <div style="border: 1px solid black; border-radius: 15px; padding: 5px; width: 180px;"> Linear-1 60.3 HZ 1000.0 N/m³ </div> </div> <p style="margin-top: 20px; text-align: center;">then save and exit</p> <p style="margin-top: 20px;">After finish the first point setup , then setup “linearity 2 “.</p> <p style="margin-top: 5px;">Note: you must setup the biggest frequency of test as the “linearity 1”.</p> <p style="margin-top: 5px;">Setup from big frequency to small frequency.</p>
Density	<p>Float point: 999999~0.1 kg/m³ · default = 1000.0 kg/m³</p> <p>This parameter is only use for liquid and need mass flow meter .</p> <p>For gas , have no any function, use for liquid only and Kg unit</p>

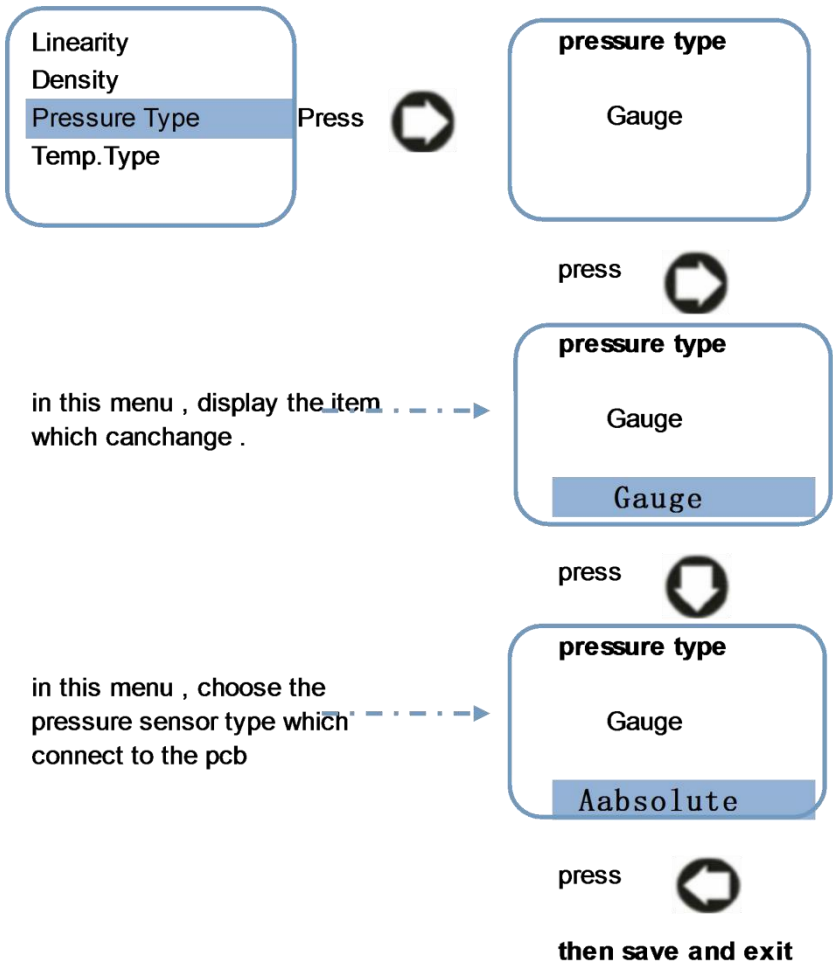
<p>Pressure Type <i>(for gar turbine flow meter)</i></p>	<p>Choose the pressure sensor type . <i>only for gar turbine flow meter</i> Option: absolute, gauge and fix pressure value Default :absolute</p>  <p>in this menu , display the <u>item</u> which canchange .</p> <p>in this menu , choose the pressure sensor type which connect to the pcb</p> <p>If you do not install the pressure sensor , you can setup the “fix pressure value” .but this fix pressure value is gauge only .</p>
<p>Temp. Type <i>(for gar turbine flow meter)</i></p>	<p>Choose the temperature sensor type . <i>(for gar turbine flow meter)</i> Option:Pt1000 , Pt100 and fix temperature value Default :Pt1000 Modified method is the same with “pressure type”</p>
<p>Local atm. (Atmospheric Pressure)</p>	<p>Float point Default :0.101 mPa If measure the liquid, then this parameter have no affect.</p>
<p>STP.Z</p>	<p>Gas compression coefficient in working state <i>(for gar turbine flow meter)</i> Default : 1.000 If measure the liquid , then this parameter have no affect.</p>
<p>Normal.Z</p>	<p>Gas compression coefficient in stardard state <i>(for gar turbine flow meter)</i> Default :1.000 If measure the liquid , then this parameter have no affect.</p>

2.4 How to Setup The Parameter

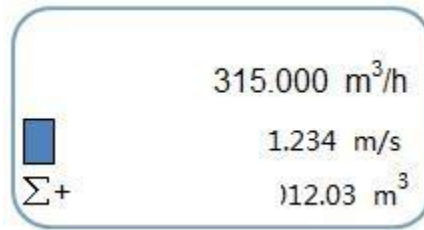



Figure 1: flow rate display interface

press  to parameter setup menu, As shown in Figure 2:

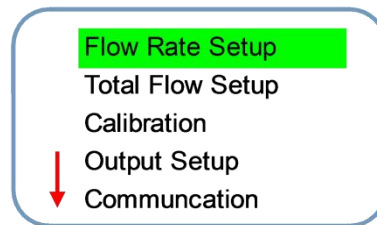







Figure 2

After the interface is shown in Figure  or  then you can choose different set items.

Press  then return to the flow display interface (figure 1) ;

Press  or  move the cursor to the sub menu, press  go to sub menu to setup the parameter,





for example , we need setup the “flowrate parameter”, when this item become , then will display the menu as shown in figure 3 :

Figure 3

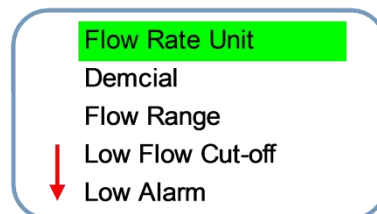

Press  or  to select the item which you want to modify, The selected item will brighten, if need return to the menu as shown in figure 2, then press  ; If you need to enter the next level of items, then press  to setup the parameters as shown in figure 4:

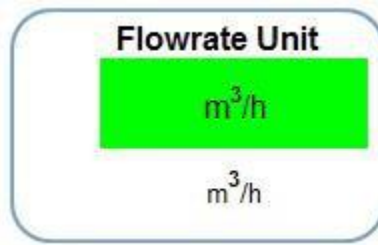





Figure 4

In this case, press  or  to modify the parameter, for example, as shown in figure 4, you need change the flowrate unit from " m^3/h " to " m^3/m ", then , the flowrate unit will become to " m^3/m ", as shown in figure 5:

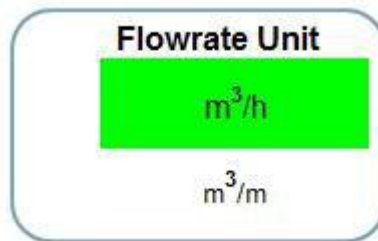



Figure 5

After you modify the parameter, if you need save, then , The system will prompt the "confirmation" and "exit" option, as shown in Figure 6:





图 6

In this , then save the setup and back (as shown in figure 3); if do not need save the parameter, then  to back (as shown in figure 3)。

3. Wiring Diagram And Output Define

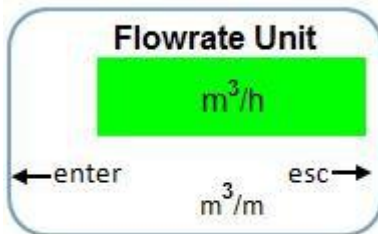
3.1 4-20mA Current Output Wiring Diagram

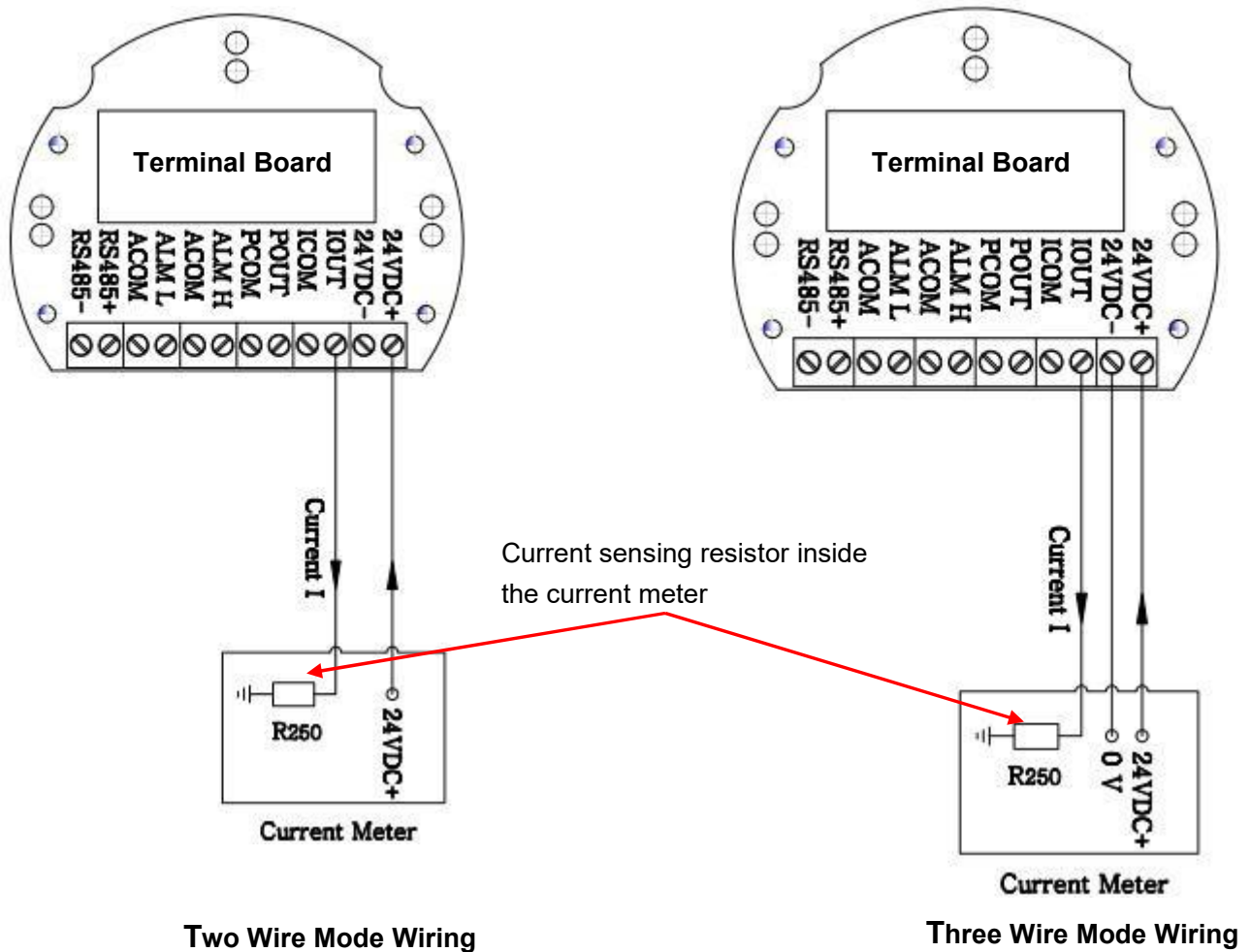

The Define of Each Terminal

Terminal Symbol	Funcation	Remarks
24V +	DC 18 - 36V +	Power supply 24V +
24 -	DC 18~36v -	Power supply 24V -
IOUT	4~20Ma +	The load resistance is less than or equal to 500.ohm
ICOM	4~20mA -	
POUT	Frequency & Pulse output +	
PCOM	Frequency & Pulse output -	
ALM H	High alarm output +	Suggest use 24VDC intermediate relay, Load current ≤ 30mA
ACOM	High alarm output -	
ALM L	Low alarm output +	
ACOM	low alarm output -	
RS+	RS485 +	RS485 terminal
RS-	RS485 -	

3.2 Pulse Output Wiring Diagram

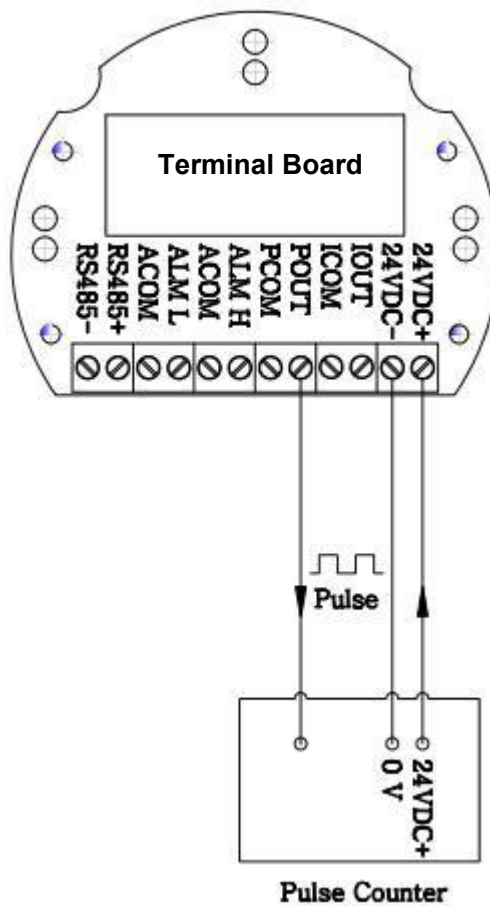

3.3 Wiring Between Transmitter And Sensor

Terminal Define of Main Board

Terminal Symbol	Function	Remarks
SIGA	Signal terminal 1 of turbine meter sensor	
SIGB	Signal terminal 2 of turbine flow meter sensor	
V+	Power (+) to pressure sensor	Connect to pressure sensor
V-	Power (-) to pressure sensor	
P+	Signal(+) of pressure output	
P-	Signal(-) of pressure output	
RTD+	Thermal resistance	Pt100 or Pt1000, two-wire
RTD-	Thermal resistance	

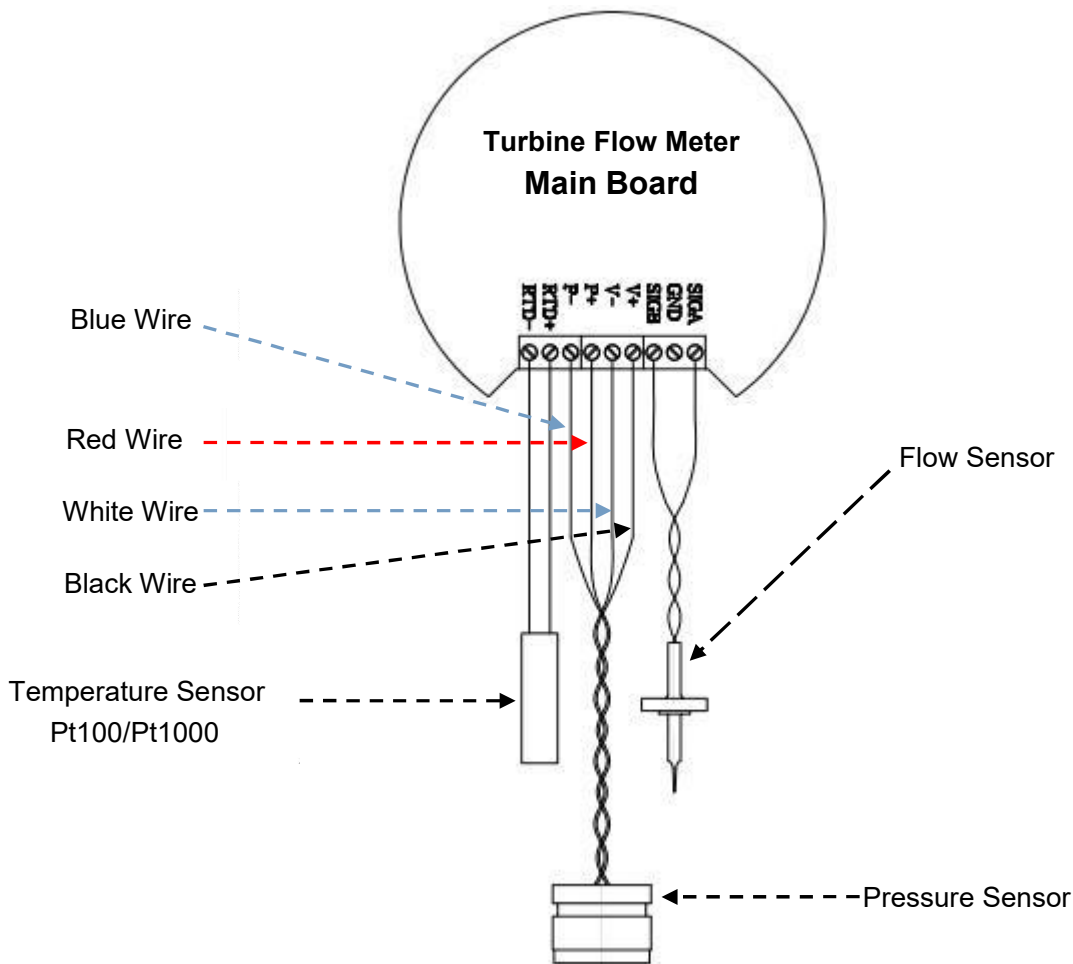

3.4 Frequency Output Mode:

Frequency output range is 0 to 5000HZ, the frequency output corresponds to the percentage of flowrate.

$$F = \frac{\text{Flow Rate}}{\text{Flow Range}} \times \text{Upper Frequency Limit}$$

Frequency output mode is generally used to control the occasion, because it reflects the percentage of traffic, if the user is used for measurement occasions, it should choose the pulse output mode.

The frequency output is provided with an internal 24VDC power supply and NPN way.

If you need use the frequency output mode , then three parameters must setup:

- Setup “Max frequency” in output menu
- Setup “flow range” (corresponding to max frequency) in flow rate setup menu

3.5 Pulse Equivalent Output Mode:

Pulse equivalent value: 0.001L, 0.01L, 0.1L, 1L, 0.001 M³ . The user should pay attention to the matching of the flow range and the pulse equivalent when selecting the pulse equivalent. If the flowrate is too large and the pulse equivalent selection is too small, it will cause the upper limit of the pulse output, so the pulse output frequency should be limited to the following 3000Hz. If the flowrate is small and the pulse equivalent is too large, it will cause the meter to output a pulse for a long time . In addition, it must be explained that the pulse output is different with the frequency output, the pulse output is a pulse equivalent to output a pulse, therefore, the pulse output is not very uniform. The general measurement of the pulse should use the counter meter, not choose the frequency meter.

The pulse output is provided with an internal 24VDC power supply and NPN way.

3.6 Analog Output Mode (4-20mA)

The current output corresponds to the percentage of instantaneous flow. The current output is provided with an internal 24VDC power supply.

$$I_0 = \frac{\text{Flow Rate}}{\text{Flow Range}} \times 16 + 4.0$$

For 4 ~ 20mA signal system, the current zero is 4mA. Therefore, in order to improve the resolution of the output analog current, the flow range of the flowmeter should be selected properly.

4. Key Points of Attention

4.1 Installation

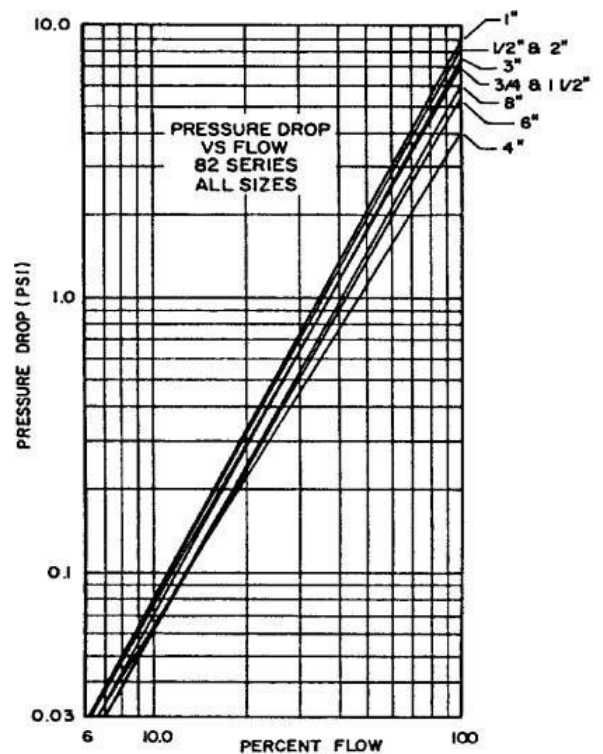
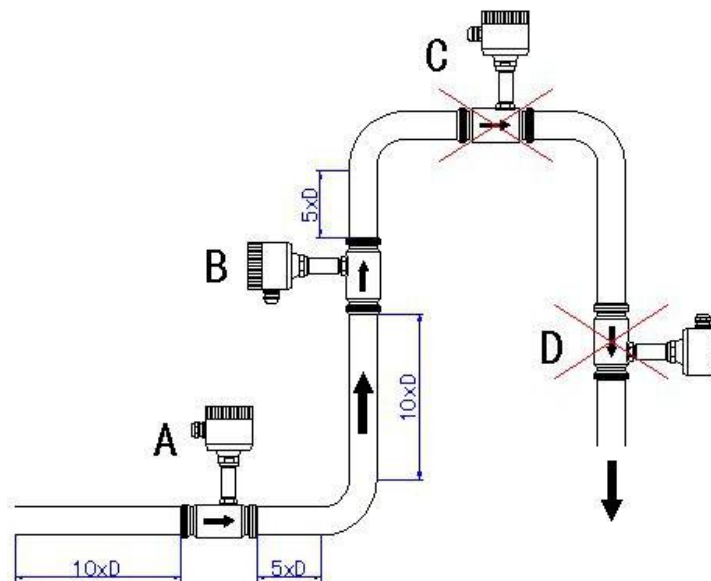

4.5 Set Up Key Parameters of Flowmeter

Go to <Factory Setup>, choose the "Medium", this is very important

Go to <Factory Setup>, choose the "Sensor Size".

Go to <Flow Rate Setup>, setup the flow Range, unit and another parameters

Go to <Output setup>, choose the output mode and parameters

5. Packing and Storage

FT8110 seal flow meter transmitter is packed in a special foam box to prevent damage during transportation. Random files include: operation manual, certificate, packing list, etc. In order to prevent the instrument from being damaged during transport, please keep the packing status of the manufacturing plant before it arrives at the installation site. Storage sites should possess the following conditions: placed in the interior and

rainproof and moisture-proof and small mechanical vibration。

Appendix "RS485 Communication Address Table"

Instrument variable address definition

The following is a list of data variables that are supported by the instrument, the data are HEX type

Variable name	Register start address	Register length	Instruction Code	Data Type
Flow Rate	0x01	0x02	0x04	float
Flow Rate Unit	0x03	0x01	0x04	int
Total Flow	0x04	0x04	0x04	double
Total Flow Unit	0x08	0x01	0x04	int
Temperature	0x09	0x02	0x04	float
Pressure	0x0b	0x02	0x04	float
Total Flow(m3)	0x0d	0x02	0x03 0x04	float
Flow Rate	0x14	0x02	0x04	float
Total Flow	0x16	0x02	0x04	float
Temperature	0x18	0x02	0x04	float
Pressure	0x1a	0x02	0x04	float
Flow Rate	0x1e	0x02	0x04	float inverse
Total Flow	0x20	0x02	0x04	float inverse
Temperature	0x22	0x02	0x04	float inverse
Pressure	0x24	0x02	0x04	float inverse

Definition of Common Units

	Unit Name	Code
Flow Rate	Nm3/h	0x00
	Nm3/m	0x01
	Nm3/s	0x02
	m3/h	0x03
	m3/m	0x04
	m3/s	0x05
	L/h	0x06
	L/m	0x07
	L/s	0x08
	usg/h	0x09
	usg/m	0x0a
	usg/s	0x0b
	kg/h	0x0c
	kg/m	0x0d
	kg/s	0x0e
	t/h	0x0f
t/m	0x10	
t/s	0x11	

Total Flow	Nm3	0x00
	m3	0x01
	L	0x02
	usg	0x03
	kg	0x04
Temperature	t	0x05